

TOO MANY CONSTRAINTS

..... to

LUBRICATE YOUR CHAINS?

For any application where lubrication is undesirable, choose :

MAINTENANCE-FREE SOLUTIONS



**TIME SAVED FOR THE
MAINTENANCE TEAM**



**SERVICE LIFE EQUAL TO
A LUBRICATED CHAIN**



**NO PRODUCTION
SHUTDOWNS**







**GLOBAL COST
SAVINGS**

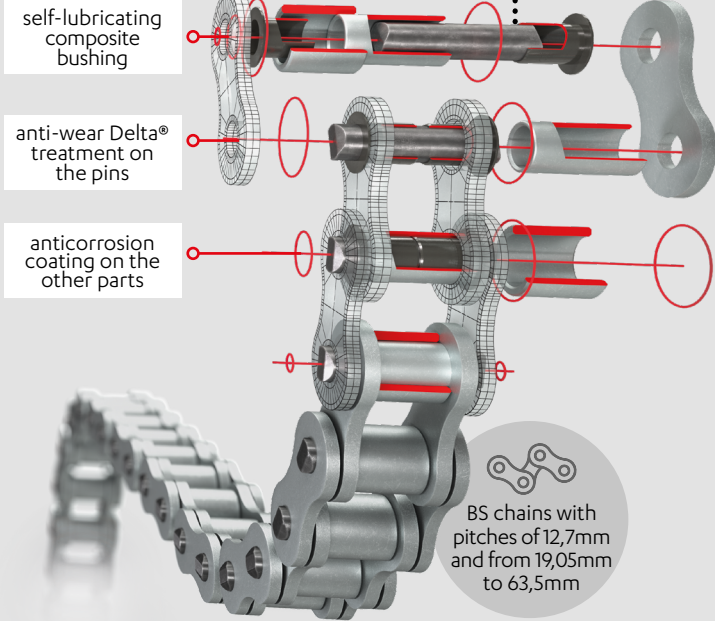

DELTA VERTE CHAIN



USE

-  low speed
-  heavy loads
-  temperatures from -30°C to +80°C
-  clean, humid or underwater environments

Composite bushings are inserted in the articulations, working **without oil**: no lubrication needed, no contamination. The Delta® pins and the anticorrosion coating give the chain an **increased corrosion and wear resistance**.

BENEFITS



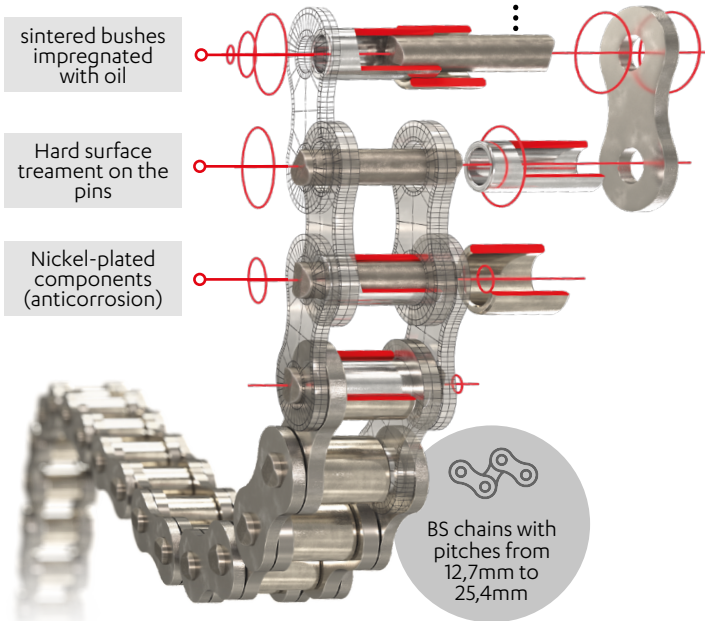

-  ANTI-WEAR & anticorrosion
-  NO contamination
-  NO RISK of fire
-  No grease: ECOLOGICAL

 **How can the DELTA® Verte chain enhance your productivity?**
Scan the QRcode to discover an example with one of our customer success!

LUB FREE VERTE CHAIN



USE

-  fast speed
-  light loads
-  temperatures from -5°C to +80°C
-  clean, low-corrosive environments

The initial oil in the **sintered bushes** lubricates continuously the articulations **without dripping**. The nickel-plating brings a **anticorrosion protection**.

BENEFITS

-  NO contamination
-  ANTICORROSION protection

 **How can the Lub Free Verte chain enhance your productivity?**
Scan the QRcode to discover an example with one of our customer success!

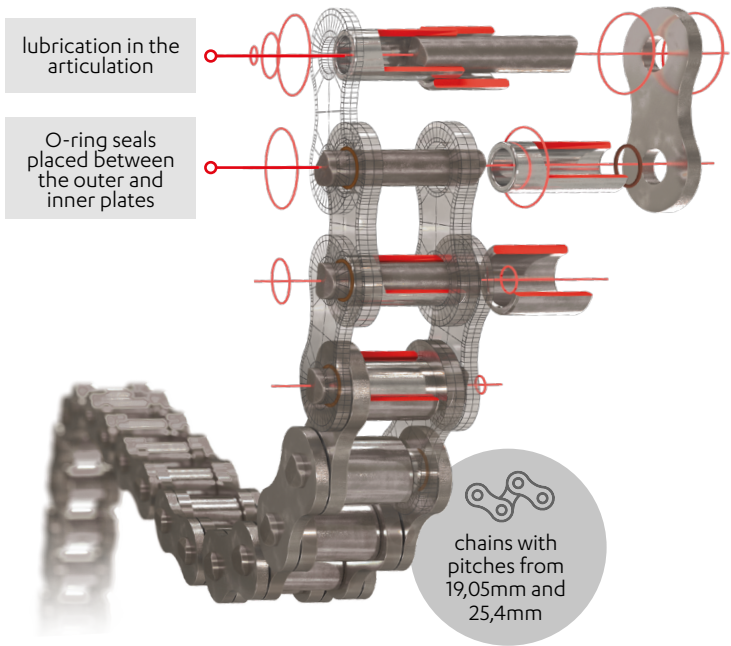

USE

- very fast speed
- dusty atmosphere
- temperatures from -5°C to +80°C
- all environments

The o-ring maintain the lubricant in the articulations and bring a sealing against the outside environment.

BENEFITS

- ALL APPLICATIONS POSSIBLE as a specific design
- ALL SPECIFIC CHAINS & TREATMENTS on request

How can the o-ring chain enhance your productivity?

Scan the QRcode to discover an example with one of our customer success !

2 MAINTENANCE-FREE SOLUTIONS

Lubrication is the guarantee of the service life of a chain. Standard chains has a lifetime which varies a lot depending on lubrication (frequency & quantity), whereas a maintenance-free chain will be more reliable and will always reach its maximum service life. Sometimes, lubrication is just difficult or too expensive to implement. SEDIS maintenance-free chains are therefore designed to work without periodic lubrication operations, while having a service life equivalent to a chain perfectly lubricated.

<p>WHEN to choose</p> <p>1. VERTES chains</p> <p><i>Ex: food, packaging, pharmaceutical, automotive industries...</i></p>	<p></p> <p>When the conveyed products <u>must not be contaminated</u> by the lubrication</p>	<p></p> <p>When the environment is not <u>abrasive or dusty</u></p>	<p></p> <p>When the <u>ambient temperature</u> is between -30 and +80°C</p>
<p>WHEN to choose</p> <p>2. O-RING chains</p> <p><i>Ex: wood, construction, agricultural industries...</i></p>	<p></p> <p>When the chain's speed is very fast</p>	<p></p> <p>When the environment is <u>abrasive or dusty</u></p>	<p></p> <p>When possible <u>contamination</u> of the product by lubrication is not an issue</p>

- Standard chains **available**. For other pitches, consult us.
- Our technicians are at your service to **select** the most suited **solution**.
- Possible adaptations** on request, even for conveyer chains

FOLLOW US ON THE **SOCIAL NETWORKS** !



SEDIS - HEAD OFFICE

6 rue Nicolas Siret
CS 90104 - 10003 TROYES
FRANCE

 +33 (0)3 25 76 29 50
 <https://sedis.com/contact>
 www.sedis.com

SEDIS - LOGISTIC PLATFORM

9 rue de la douane
10600 LA CHAPELLE SAINT LUC
FRANCE

 +33 (0)3 10 64 17 80

SEDIS - TROYES FACTORY

35 rue des bas Trévois
CS 90104 - 10003 TROYES
FRANCE

 +33 (0)3 25 76 29 50



SEDIS - VERRIÈRES FACTORY

6 rue de Verjoux
25300 VERRIERES-DE-JOUX
FRANCE

 +33 (0)3 81 38 40 60



SEDIS COMPANY LTD

248 Mackadown Lane, Kitts Green
BIRMINGHAM, B33 0LE
UNITED KINGDOM

 +44 (0)121 783 2636
 sales@sedis.co.uk



SEDIS ITALIA

Via Pietro Mascagni 42
20030 SENAGO (MI)
ITALIA

 +39 (0)2 47 76 11 97
 aconan@sedis.com

SEDIS GMBH

Im Grashof 8
D- 38259 Salzgitter
DEUTSCHLAND

 +49 (0)173 211 3354
 spidansat@sedis.com