

# CADENAS CON PLACAS DE ARRASTRE

## EJEMPLO DE FABRICACIÓN

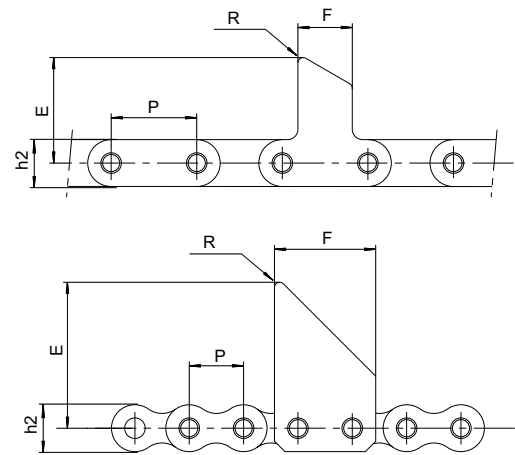
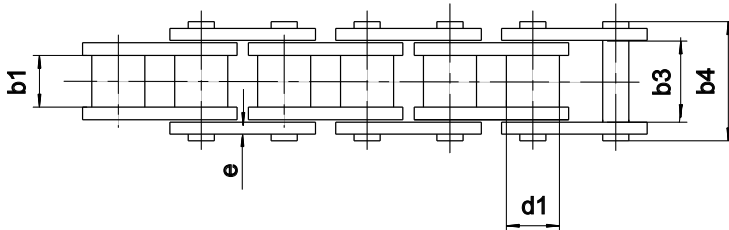

Dimensiones en mm

Referencia SEDIS	P	d1	b1	b3	b4	h2	e	E	F	R	Resistencia a la tracción
		max.	min.	min.	max.	max.	med.	max.	max.		kN
<b>Placas rectas</b>											
5310-04	63,5	25,40	25,33	38,05	53,1	32,0	5	76	50	4	180
5310-05	63,5	25,40	25,33	38,05	53,1	32,0	5	134	50	4	180
<b>Placas estándar</b>											
17T	31,75	19,05	19,56	29,15	40,5	25,4	3,5	82	58	3	105
18T	38,1	25,40	25,4	38,05	53,1	32,3	5	76	75	4	180

Las versiones DELTA®, DELTA TITANIUM y DELTA® VERTE están disponibles

Toda forma y dimensión realizable. Consúltenos.

# CADENAS CON PINZAS

## TIPO 1

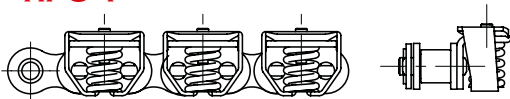

### CON PINZAS RECTAS

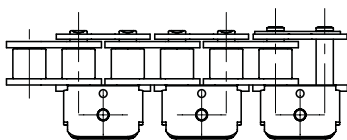

### CON PINZAS CORAZÓN

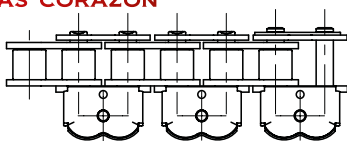

## TIPO 2

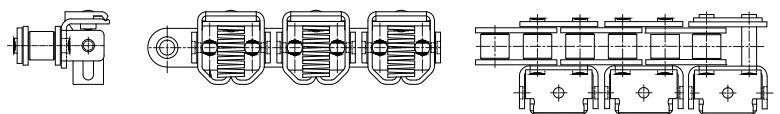

## TIPO 3

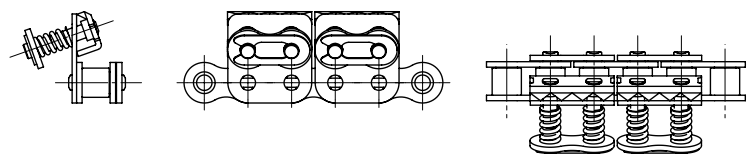

- Muelles con diferentes resistencias (50N Y 100N)
- Pinzas inoxidable de formas diferentes (corazón, recta)
- Cadena Delta Z o niquelada
- Paso de 12,7mm y de 15,875mm

Larga gama de cadenas con pinzas. Consúltenos.