

ANGLED VERTICAL PLATE CHAINS

EXAMPLES OF MANUFACTURING

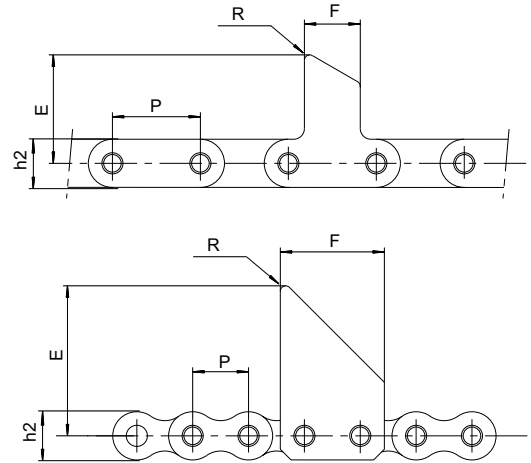
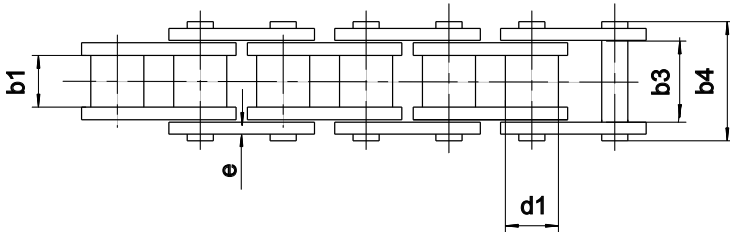

Dimensions in mm

SEDIS References	P	d1	b1	b3	b4	h2	e	E	F	R	Minimum Breaking load kN
		max.	min.	min.	max.	max.	nom.	max.	max.		
Straight side plates											
5310-04	63,5	25,40	25,33	38,05	53,1	32,0	5	76	50	4	180
5310-05	63,5	25,40	25,33	38,05	53,1	32,0	5	134	50	4	180
Waisted plates											
17T	31,75	19,05	19,56	29,15	40,5	25,4	3,5	82	58	3	105
18T	38,1	25,40	25,4	38,05	53,1	32,3	5	76	75	4	180

DELTA®, DELTA® TITANIUM and DELTA® VERTE versions are also available

All shapes and dimensions possible. Please consult us.

GRIPPER CHAINS

TYPE 1

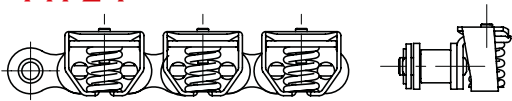

STRAIGHT CLAMP DESIGN

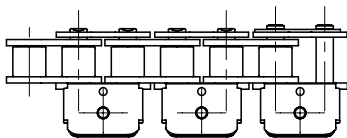

HEART CLAMP DESIGN

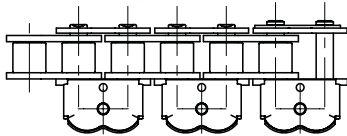

TYPE 2

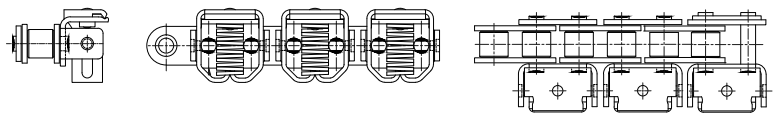

TYPE 3

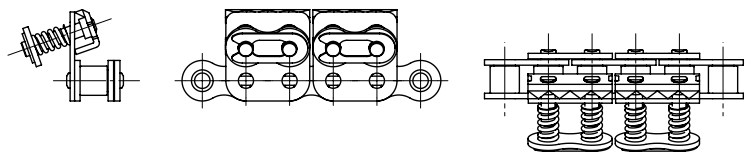

- Springs available with 50N or 100N resistance
- Different shapes of stainless steel grippers available
- Delta® Titanium 2 or nickel-plated versions
- Pitches of 12.7mm and of 15.875mm

Large range of gripper chains. Please consult us.