

CATENE CON SPINTORI

ESEMPI DI FABBRICAZIONI

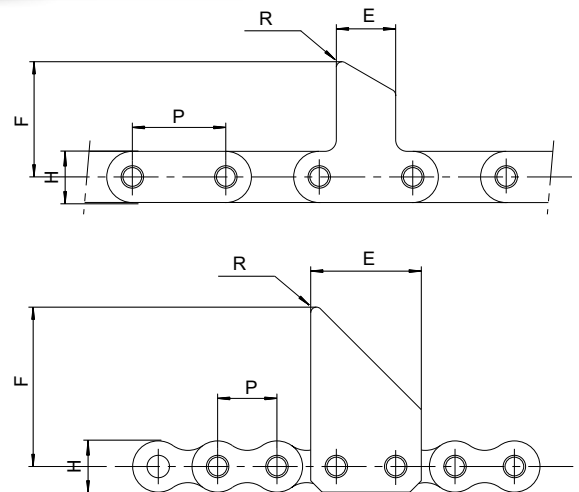
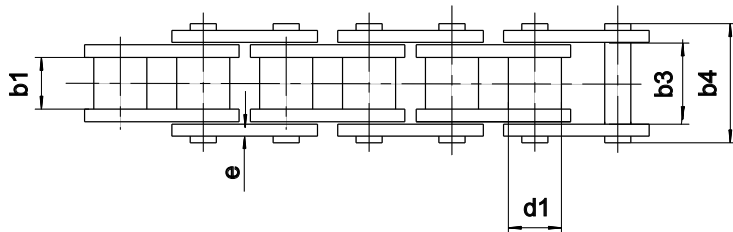

Dimensioni in mm

Riferimento SEDIS	P	d1 max.	b1 min.	b3 min.	b4 max.	e	E	F max.	H min.	R	Resistenza minima alla trazione kN
Piastre dritte											
5310-04	63,5	25,40	25,33	38,05	53,1	5,2	50	76	32,0	4	180
5310-05	63,5	25,40	25,33	38,05	53,1	5,2	50	134	32,0	4	180
Piastre sagomate											
17T	31,75	19,05	19,42	29,15	40,5	3,7	58	82	25,4	3	105
18T	38,1	25,40	25,33	38,05	53,1	5,2	75	76	33,5	4	180

Le versioni DELTA®, DELTA® TITANIUM 2 e DELTA® VERTE sono possibili.

Tutte le forme e dimensioni realizzabili. Consultateci.

CATENE A PINZE

TIPO 1

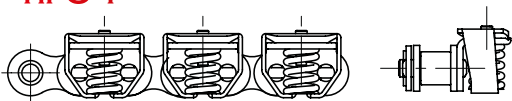

A PINZE DIRITTE

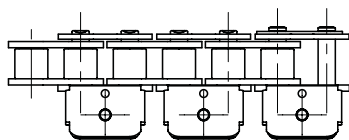

A PINZE A CUORE

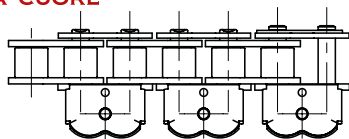

TIPO 2

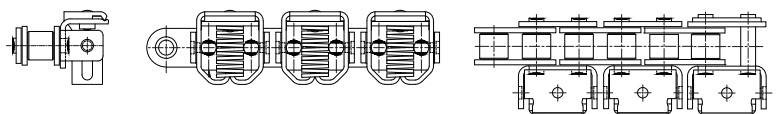

TIPO 3

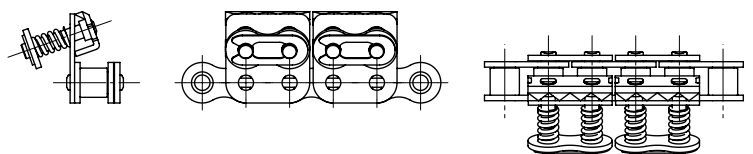

- Molle con varie resistenze (50N - 100N)
- Pinze inox con varie forme possibili (a cuore o diritte)
- Catena Delta® Titanium 2 o nichelata
- Passo 12,7mm e de 5,875mm

Ampia gamma di catene a pinze. Consultateci.